

 Ø6,3x50 mm <b>A1 x 8</b>	 Ø12 mm <b>A2 x 8</b>	 4 mm <b>A3 x 1</b>	 Ø4x30 mm <b>D x 4</b>	 Ø1,6x25 mm <b>F x 32</b>
 Ø5x16 mm <b>L x 8</b>	 <b>M x 4</b>	 682 mm <b>O x 2</b>	 Ø8x30 mm <b>T x 2</b>	 <b>U1 x 2</b>
 <b>U2 x 2</b>				



**Box**

715x280x16 mm

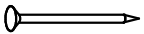
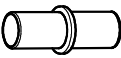
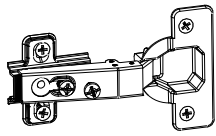
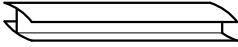
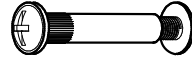
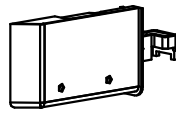
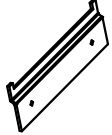
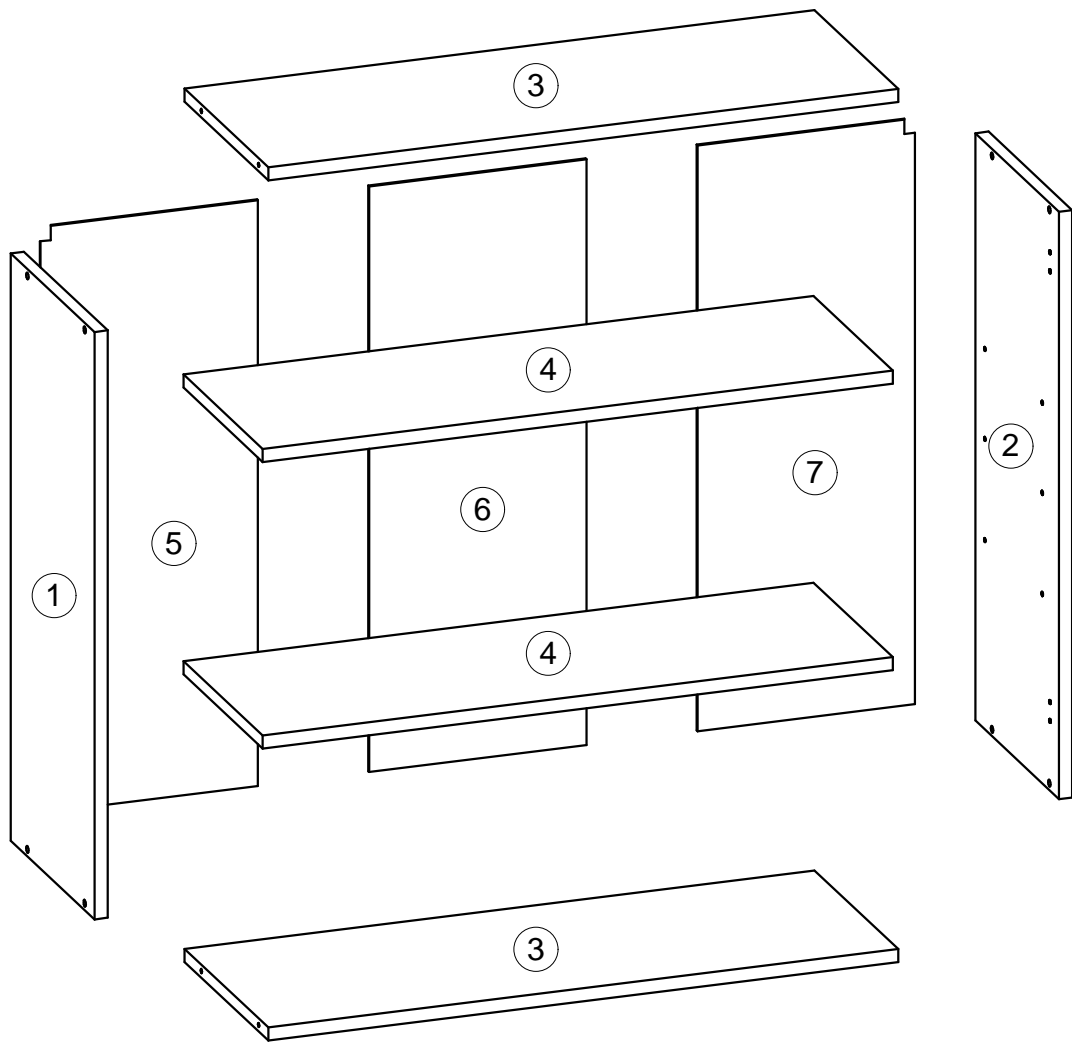
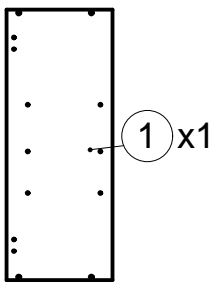

715x280x16 mm

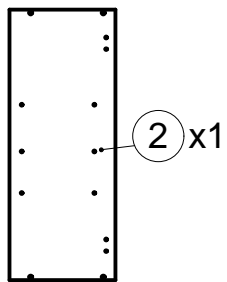

768x280x16 mm

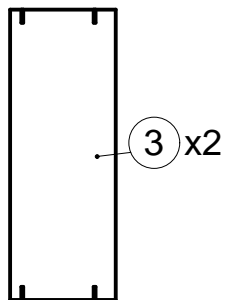

768x260x16 mm

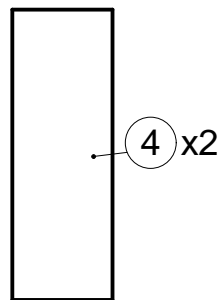

714x265x3 mm

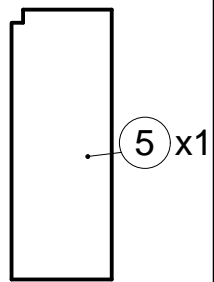

714x265x3 mm

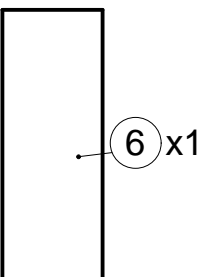

714x265x3 mm

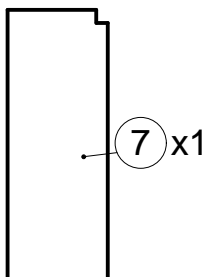

Fittings & Tools

1

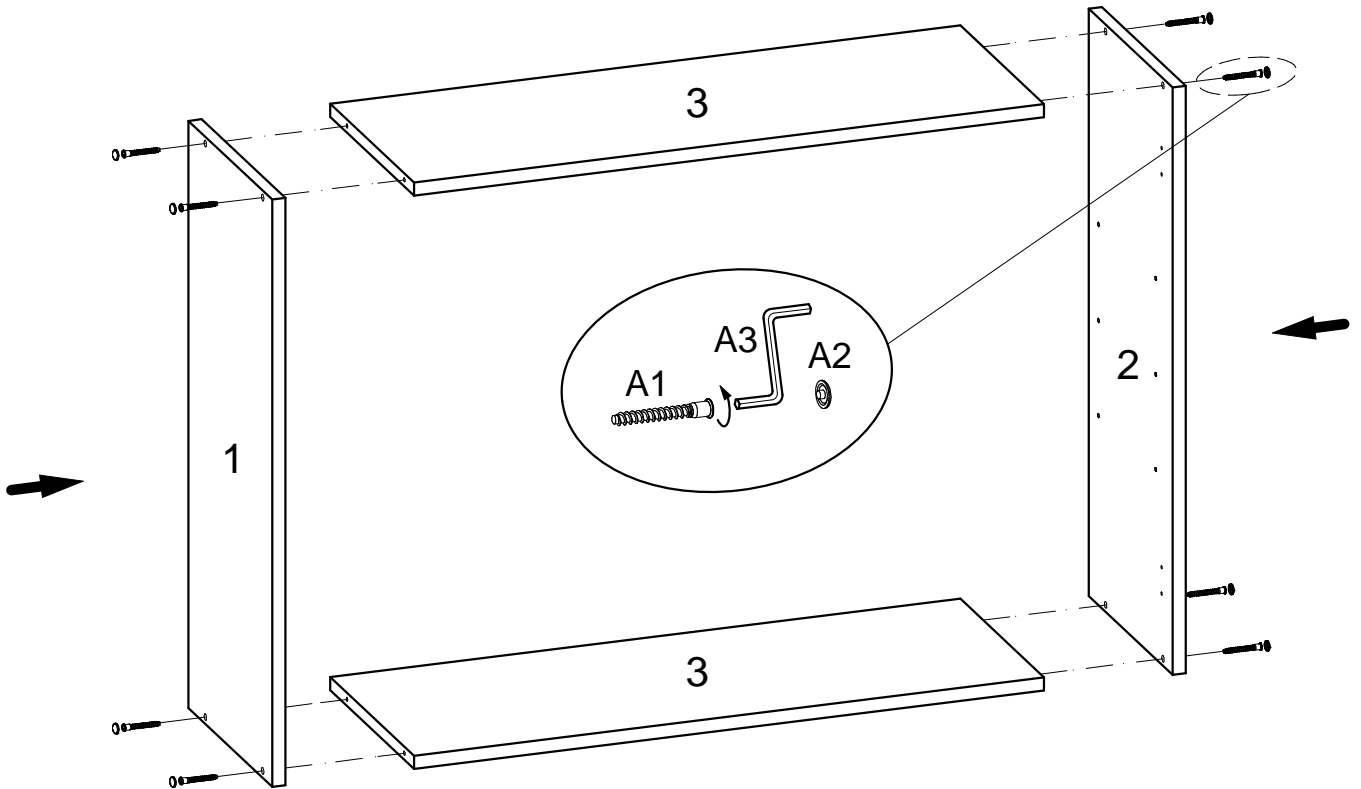
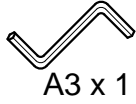
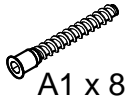

2

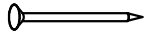

F x 32

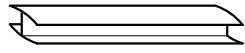

O x 2

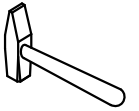

$XX=YY\cong 90^\circ$

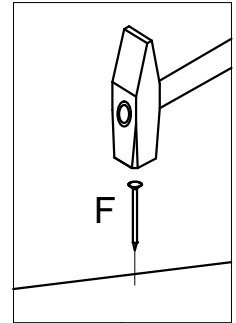
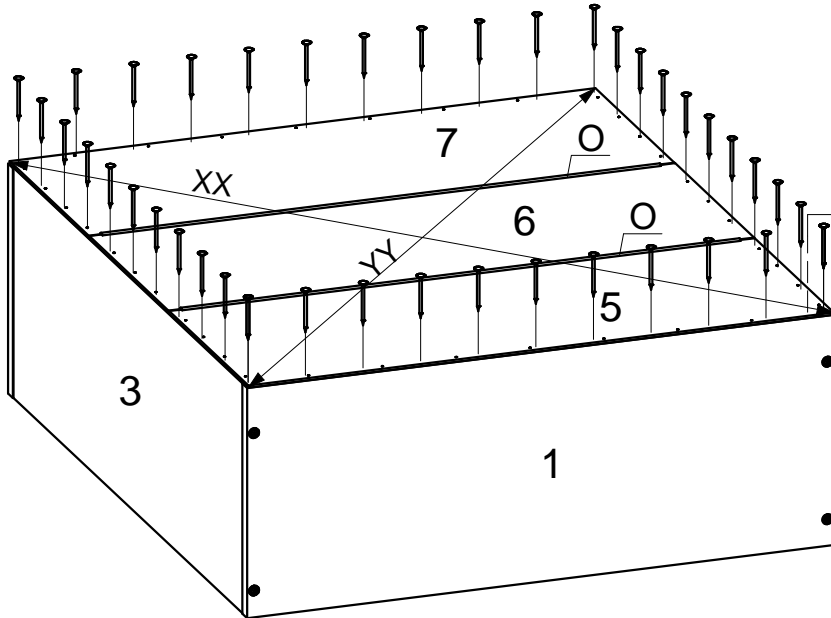

3



L x 8



M.1 x 4

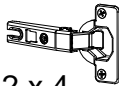

M.2 x 4

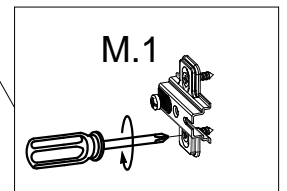
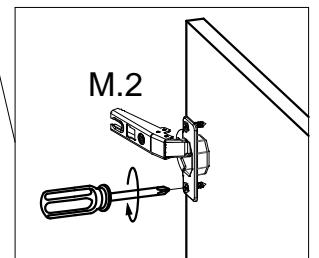
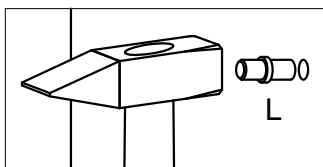
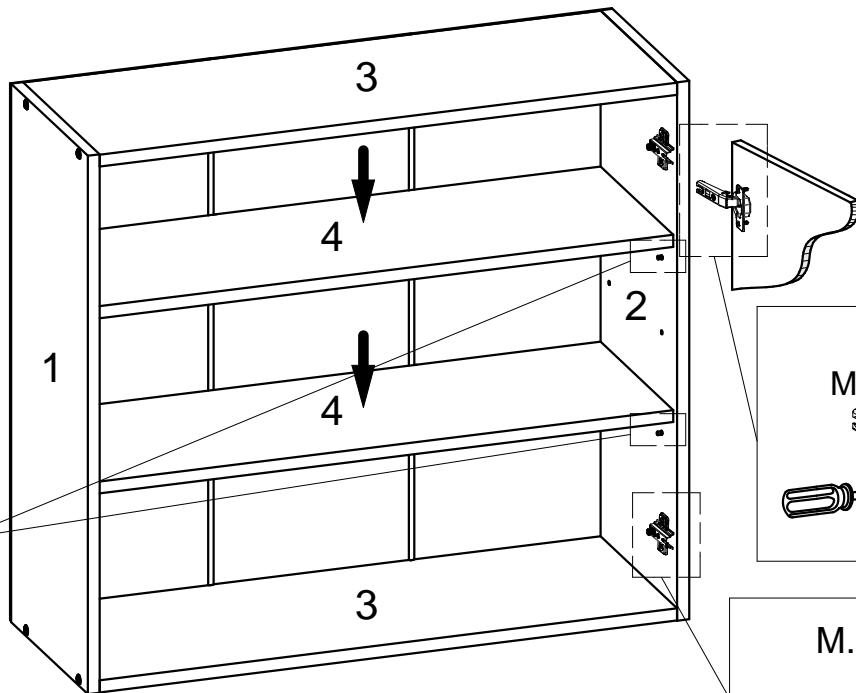
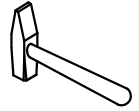
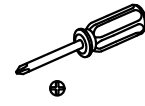



D x 4

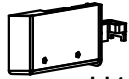

U1 x 2

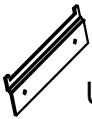
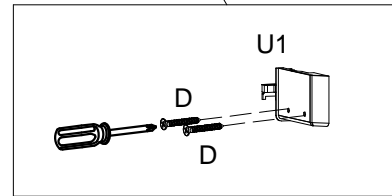
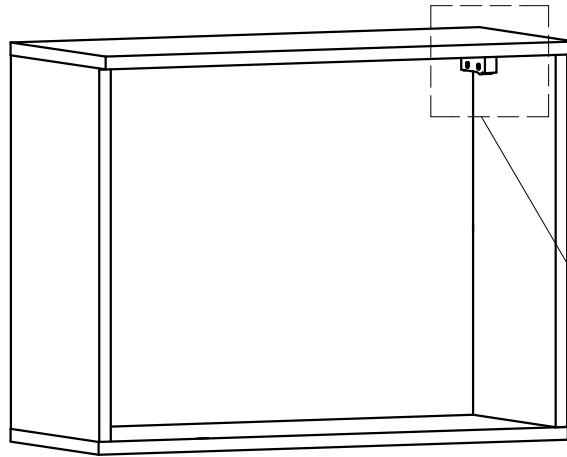
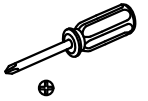

U2 x 2

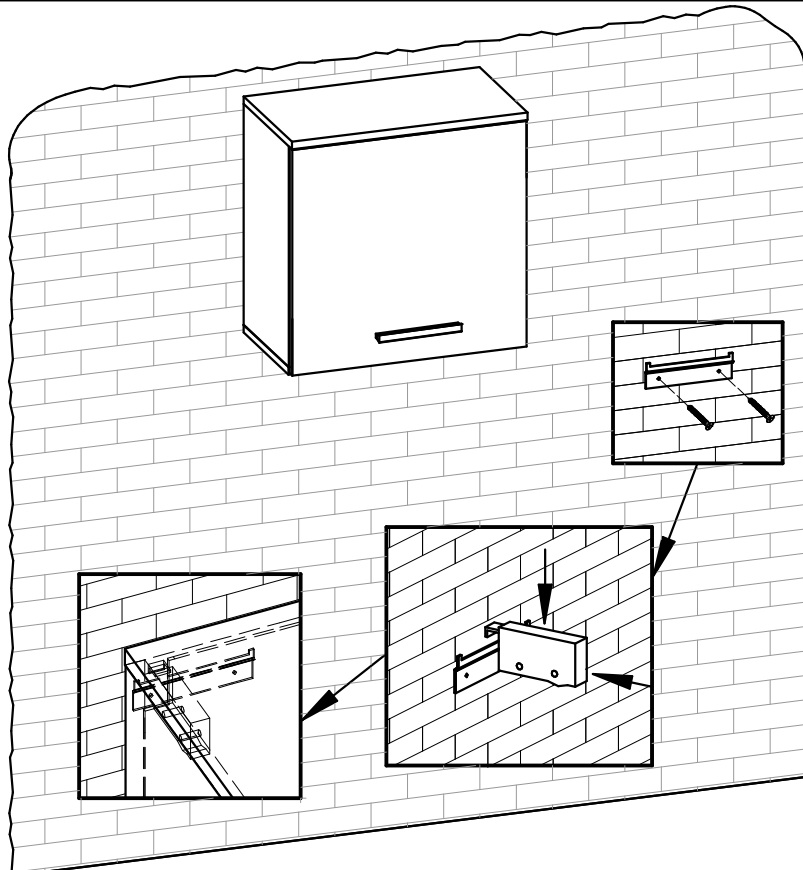



T x 2

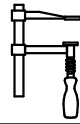

Ø8

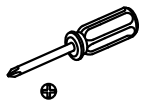
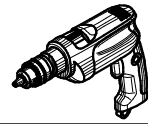

1

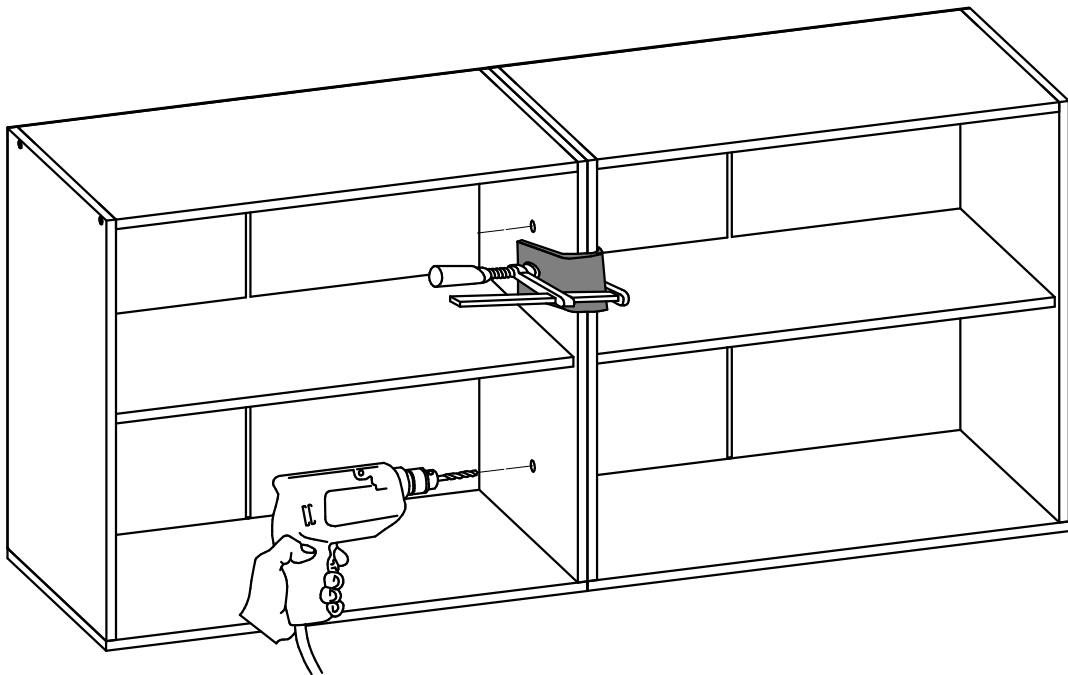

2

